

**TABLE DES MATIÈRES**  
**TABLE OF CONTENTS**



**PVC CÉDULE 80 GRIS**

TÉ COLLÉ .....	
TÉ RÉDUIT COLLÉ .....	
TÉ COLLÉ X FILETÉ .....	
TÉ RENFORCÉ COLLÉ X FILETÉ .....	
TÉ DE TRANSITION .....	
TÉ RÉDUIT COLLÉ X FILETÉ .....	
TÉ RENFORCÉ COLLÉ X FILETÉ .....	
TÉ DE TRANSITION .....	
TÉ FILETÉ .....	
TÉ RENFORCÉ FILETÉ .....	

COUDE 90 <sup>0</sup> COLLÉ .....	
COUDE 90 <sup>0</sup> COLLÉ X FILETÉ .....	
COUDE 90 <sup>0</sup> RENFORCÉ COLLÉ X FILETÉ .....	
COUDE 90 <sup>0</sup> DE TRANSITION .....	
COUDE 90 <sup>0</sup> RÉDUIT COLLÉ X FILETÉ .....	
COUDE 90 <sup>0</sup> RÉDUIT DE TRANSITION .....	
COUDE 90 <sup>0</sup> FILETÉ .....	
COUDE 90 <sup>0</sup> RENFORCÉ FILETÉ .....	
COUDE 90 <sup>0</sup> SPIGOT X COLLÉ .....	
COUDE 11-1/4 <sup>0</sup> COLLÉ .....	
COUDE 90 <sup>0</sup> FILETÉ .....	
COUDE 30 <sup>0</sup> COLLÉ .....	
COUDE 22-1/2 <sup>0</sup> COLLÉ .....	
COUDE 45 <sup>0</sup> COLLÉ .....	
COUDE 15 <sup>0</sup> COLLÉ .....	
COUDE 45 <sup>0</sup> FILETÉ .....	
COUDE 45 <sup>0</sup> RENFORCÉ FILETÉ .....	

CROIX COLLÉE .....	
CROIX RÉDUITE COLLÉE .....	

COUDE 60 <sup>0</sup> COLLÉ .....	
COUDE 45 <sup>0</sup> SPIGOT X COLLÉ .....	

MANCHON COLLÉ .....	
MANCHON RÉDUIT COLLÉ .....	
MANCHON RÉDUIT EXCENTRIQUE COLLÉ .....	
MANCHON FILETÉ .....	

**PVC SCHEDULE 80 GRAY**

TEE SOC .....	4
REDUCING TEE SOC .....	4-5
TEE SOC X FIPT .....	6
SPECIAL REINFORCED TEE SOC X SR FIPT .....	6
TRANSITION TEE SOC X FIPT .....	6
REDUCING TEE SOC X FIPT .....	6-7
SPECIAL REINFORCED REDUCING TEE SOC X SR FIPT .....	7
TRANSITION REDUCING TEE SOC X SR FIPT .....	7
TEE FIPT .....	7-8
SPECIAL REINFORCED TEE SR FIPT .....	8

90 <sup>0</sup> ELL SOC .....	8
90 <sup>0</sup> ELL SOC X FIPT .....	8
SPECIAL REINFORCED 90 <sup>0</sup> ELL SOC X SR FIPT .....	9
TRANSITION 90 <sup>0</sup> ELL SOC X FIPT .....	9
REDUCING 90 <sup>0</sup> ELL SOC X FIPT .....	9
TRANSITION REDUCING 90 <sup>0</sup> ELL SOC X FIPT .....	9
90 <sup>0</sup> ELL FIPT .....	9
SPECIAL REINFORCED 90 <sup>0</sup> ELL SR FIPT .....	9
90 <sup>0</sup> STREET ELL SPIG X SOC .....	9-10
11-1/4 <sup>0</sup> ELL SOC .....	10
90 <sup>0</sup> STREET ELL MIPT X FIPT .....	10
30 <sup>0</sup> ELL SOC .....	10
22-1/2 <sup>0</sup> ELL SOC .....	11
45 <sup>0</sup> ELL SOC .....	11
15 <sup>0</sup> ELL SOC .....	11-12
45 <sup>0</sup> ELL FIPT .....	12
SPECIAL REINFORCED 45 <sup>0</sup> ELL SR FIPT .....	12

CROSS SOC .....	12
REDUCING CROSS SOC .....	12-14

60 <sup>0</sup> ELL SOC .....	14
45 <sup>0</sup> STREET ELL SPIG X SOC .....	14

COUPLING SOC .....	14-15
REDUCER COUPLING SOC .....	15-16
ECCENTRIC REDUCER COUPLING SOC .....	16
COUPLING FIPT .....	17

MANCHON RENFORCÉ FILETÉ .....	SPECIAL REINFORCED COUPLING SR FIPT .....	17
MANCHON RÉDUIT FILETÉ .....	REDUCER COUPLING FIPT X FIPT .....	17
MANCHON RÉDUIT RENFORCÉ FILETÉ .....	SPECIAL REINFORCED REDUCER COUPLING SR FIPT .....	17
ADAPTATEUR FEMELLE .....	FEMALE ADAPTER SOC X FIPT .....	18
ADAPTATEUR FEMELLE RENFORCÉ .....	SPECIAL REINFORCED FEMALE ADAPTER SOC X SR FIPT.....	18
ADAPTATEUR FEMELLE DE TRANSITION .....	TRANSITION FEMALE ADAPTER SOC X FIPT .....	18
ADAPTATEUR FEMELLE RÉDUIT DE TRANSITION .....	TRANSITION FEMALE ADAPTER SOC X FIPT .....	18
ADAPTATEUR FEMELE RÉDUIT RENFORCÉ .....	SPECIAL REINFORCED REDUCING FEMALE ADAPTER SOC X SR FIPT .....	19
ADAPTATEUR MÂLE .....	MALE ADAPTER MIPT X SOC .....	19
ADAPTATEUR MÂLE RENFORCÉ .....	REINFORCED MALE ADAPTER MIPT X SOC .....	19
RÉDUIT SPIGOT X COLLÉ .....	REDUCER BUSHING FLUSH STYLE SPIG X SOC .....	19-20
RÉDUIT SPIGOT X FILETÉ .....	REDUCER BUSHING FLUSH STYLE SPIG X FIPT .....	21
RÉDUIT RENFORCÉ SPIGOT X FILETÉ .....	SPECIAL REINFORCED REDUCER BUSHING FLUSH STYLE SPIG X SR FIPT.	21
RÉDUIT FILETÉ X FILETÉ .....	REDUCER BUSHING FLUSH STYLE MIPT X FIPT .....	21
RÉDUIT RENFORCÉ FILETÉ X FILETÉ .....	SPECIAL REINFORCED REDUCER BUSHING MIPT X SR FIPT.	21
COUDE 22-1/2 <sup>o</sup> SPIGOT X COLLÉ .....	22-1/2 <sup>o</sup> STREET ELL SPIG X SOC .....	21
TÉ SPIGOT X COLLÉ .....	STREET TEE SPIG X SOC .....	21
CAPUCHON COLLÉ .....	CAP SOC .....	22
CAPUCHON FILETÉ .....	CAP FIPT .....	22
CAPUCHON RENFORCÉ FILETÉ .....	SPECIAL REINFORCED CAP SR FIPT .....	22
BOUCHON SPIGOT .....	PLUG SPIG .....	23
BOUCHON FILETÉ .....	PLUG MIPT .....	24
BRIDE UNE PIÈCE COLLÉE .....	FLANGE ONE PIECE SOC .....	24
BRIDE UNE PIÈCE FILETÉE .....	FLANGE ONE PIECE FIPT .....	24
BRIDE UNE PIÈCE RENFORCÉE FILETÉE .....	SPECIAL REINFORCED FLANGE ONE PIECE THREAD SR FIPT	24
BRIDE PLEINE .....	BLIND FLANGE .....	25
BRIDE TOURNANTE COLLÉE .....	FLANGE VAN STONE STYLE SOC .....	25
BRIDE TOURNANTE FILETÉE .....	FLANGE VAN STONE STYLE FIPT .....	25
BRIDE TOURNANTE SPIGOT .....	FLANGE VAN STONE STYLE SPIG .....	26
ADAPTATEUR MÂLE SPIGOT .....	MALE ADAPTER SPIG X MIPT .....	26
'' Y '' COLLÉ .....	WYE SOC .....	26
'' Y '' RÉDUIT COLLÉ .....	REDUCING WYE SOC .....	26-27
'' Y '' DOUBLE COLLÉ .....	DOUBLE WYE SOC .....	28
'' Y '' DOUBLE RÉDUIT COLLÉ .....	REDUCING DOUBLE WYE SOC .....	28
ADAPTATEUR FEMELLE RENFORCÉ SPIGOT .....	SPECIAL REINFORCED SPIG FEMALE ADAPTER SPIG X SR FIPT	28
ADAPTATEUR FEMELLE DE TRANSITION SPIGOT.....	TRANSITION FEMALE ADAPTER SPIG X FIPT .....	28
ADAPTATEUR FEMELLE RÉDUIT RENFORCÉ SPIGOT .....	SPECIAL REINFORCED REDUCING SPIG FEMALE ADAPTER SPIG X SR FIPT	29
UNION COLLÉE, JOINT VITON .....	UNION SOC WITH VITON O-RING SEAL .....	29
UNION COLLÉE, JOINT EPDM .....	UNION SOC WITH EPDM O-RING SEAL .....	29
UNION FILETÉE, JOINT VITON .....	UNION FIPT WITH VITON O-RING SEAL .....	29
UNION FILETÉE, JOINT EPDM .....	UNION FIPT WITH EPDM O-RING SEAL .....	30
UNION COLLÉE X FILETÉE JOINT VITON .....	UNION SOC X FIPT WITH VITON O-RING SEAL .....	30
UNION COLLÉE X FILETÉE, JOINT EPDM .....	UNION SOC X FIPT WITH EPDM O-RING SEAL .....	30



## PVC CÉDULE 80 GRIS PVC SCHEDULE 80 GRAY

EXEMPLE / EXAMPLE

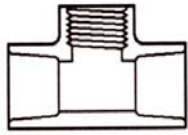
	<p><b>TÉ COLLÉ X FILETÉ</b> <b>TEE</b> <b>Soc x Fipt</b></p>	
<b>NUMÉRO DE PIÈCE</b>	<b>DIMENSION</b>	<b>EMBALAGE STAND.</b>
<b>PART NUMBER</b>	<b>SIZE</b>	<b>STAND. PACK</b>
81.802-003	3/8	50
81.802-005	1/2	20
81.802-007	3/4	15

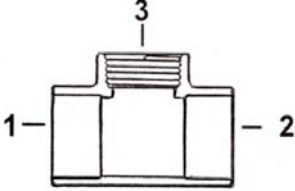
<p><b>NOM DU PRODUIT</b>            <b>TE</b> <b>DESCRIPTION ABRÉGÉE .... COLLE X FILETE</b> <b>DE LA CONFIGURATION</b></p>		<p><b>PRODUCT NAME</b> ..... <b>TEE</b> <b>ABBREVIATED</b> ..... <b>SOC X FIPT</b> <b>CONFIGURATION DESCRIPTION</b></p>
<p><b>DANS CET EXEMPLE, LA DESCRIPTION DES SORTIES EST COLLE X FILETE, CE QUI SIGNIFIE:</b></p> <p><b>1. COLLE X</b> <b>2. COLLE X</b> <b>3. FILETAGE FEMELLE NPT</b></p>		<p><b>IN THIS EXAMPLE CONFIGURATION OUTLET DESCRIPTION IS SOC X FIPT, WHICH INDICATES :</b></p> <p><b>1. SOCKET X</b> <b>2. SOCKET X</b> <b>3 FEMALE IRON PIPE THREADED</b></p>

*NOTE: CSR = Anneau de renfort en acier inoxydable  
S.S.. reinforcement ring.*

*NOTE : CBR = Insertion de transition en laiton  
Brass transition insert*

PVC CÉDULE 80 GRIS / PVC SCHEDULE 80 GRAY

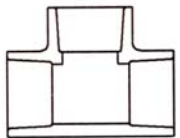

**TÉ COLLÉ**  
**TEE Soc**

NUMÉRO DE PIÈCE	DIMENSION	EMBALAGE STAND.
PART NUMBER	SIZE	STAND. PACK
81.801-002 (S)	1/4	25
81.801-003 (S)	3/8	25
81.801-005 (S)	1/2	25
81.801-007 (S)	3/4	15
81.801-010 (S)	1	15
81.801-012 (S)	1-1/4	10
81.801-015 (S)	1-1/2	10
81.801-020 (S)	2	10
81.801-025 (S)	2-1/2	10
81.801-030 (S)	3	5
81.801-040 (S)	4	5
81.801-050	5	1
81.801-060 (S)	6	4
81.801-080 (S)	8	2
81.801-100 (S)	10	1
81.801-120 (S)	12	1
81.801-140	14	1
81.801-160	16	1
81.801-180	18	1
81.801-200	20	1
81.801-240	24	1

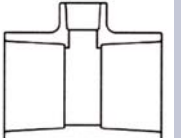

**TÉ RÉDUIT COLLÉ**  
**REDUCING TEE Soc**

NUMÉRO DE PIÈCE	DIMENSION	EMBALAGE STAND.
PART NUMBER	SIZE	STAND. PACK
81.801-168 (S)	1-1/4 x 1	15
81.801-202	1-1/2 x 1-1/4 x 1	10
81.801-209	1-1/2 x 1/2	10
81.801-210 (S)	1-1/2 x 3/4	15
81.801-211 (S)	1-1/2 x 1	10
81.801-212 (S)	1-1/2 x 1-1/4	1
81.801-247 (S)	2 x 1/2	10
81.801-248 (S)	2 x 3/4	10
81.801-249 (S)	2 x 1	10
81.801-250 (S)	2 x 1-1/4	10
81.801-251 (S)	2 x 1-1/2	10
81.801-288	2-1/2 x 3/4	10
81.801-289 (S)	2-1/2 x 1	10
81.801-290	2-1/2 x 1-1/4	10
81.801-291	2-1/2 x 1-1/2	10
81.801-292 (S)	2-1/2 x 2	10
81.801-333	3 x 1/2	5
81.801-334	3 x 3/4	5
81.801-335	3 x 1	5
81.801-336	3 x 1-1/4	5
81.801-337 (S)	3 x 1-1/2	5
81.801-338 (S)	3 x 2	5
81.801-339 (S)	3 x 2-1/2	5
81.801-416	4 x 3/4	5
81.801-417	4 x 1	5
81.801-418	4 x 1-1/4	5
81.801-419	4 x 1-1/2	5
81.801-420 (S)	4 x 2	5
81.801-421	4 x 2-1/2	5
81.801-422 (S)	4 x 3	5
81.801-426	4 x 6	4
81.801-482	5 x 1-1/4	1
81.801-484	5 x 1-1/2	1
81.801-486	5 x 2	1
81.801-487	5 x 2-1/2	1
81.801-488	5 x 3	1
81.801-490	5 x 4	1
81.801-525	6 x 1	4
81.801-526	6 x 1-1/4	4

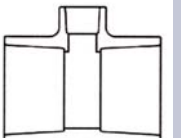

**TÉ RÉDUIT COLLÉ**  
**REDUCING TEE Soc**

NUMÉRO DE PIÈCE	DIMENSION	EMBALAGE STAND.
PART NUMBER	SIZE	STAND. PACK
81.801-101 (S)	3/4 x 1/2	15
81.801-130 (S)	1 x 1/2	15
81.801-131 (S)	1 x 3/4	15
81.801-157 (S)	1-1/4 x 1 x 3/4	15
81.801-158	1-1/4 x 1 x 1	15
81.801-159	1-1/4 x 1 x 1-1/4	15
81.801-166	1-1/4 x 1/2	10
81.801-167	1-1/4 x 3/4	10

☞ Note: ( S ) normalement en inventaire / (S) normally available from inventory

PVC CÉDULE 80 GRIS / PVC SCHEDULE 80 GRAY

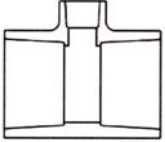

**TÉ RÉDUIT COLLÉ  
REDUCING TEE  
Soc**

NUMÉRO DE PIÈCE	DIMENSION	EMBALAGE STAND.
PART NUMBER	SIZE	STAND. PACK
81.801-527	6 x 1-1/2	4
81.801-528	6 x 2	4
81.801-529	6 x 2-1/2	4
81.801-530	6 x 3	4
<b>81.801-532 (S)</b>	6 x 4	5
81.801-533	6 x 5	1
81.801-537	6 x 10	1
81.801-539	6 x 12	1
81.801-578	8 x 2	2
81.801-579	8 x 2-1/2	1
81.801-580	8 x 3	2
81.801-582	8 x 4	1
81.801-583	8 x 5	1
<b>81.801-585 (S)</b>	8 x 6	2
81.801-621	10 x 2	1
81.801-622	10 x 2-1/2	1
81.801-623	10 x 3	1
81.801-624	10 x 4	1
81.801-625	10 x 5	1
81.801-626	10 x 6	1
81.801-628	10 x 8	1
81.801-632	10 x 12	1
81.801-661	12 x 2	1
81.801-662	12 x 2-1/2	1
81.801-663	12 x 3	1
81.801-664	12 x 4	1
81.801-665	12 x 5	1
81.801-666	12 x 6	1
<b>81.801-668 (S)</b>	12 x 8	1
81.801-670	12 x 10	1
81.801-678	12 x 18	1
81.801-691	14 x 2	1
81.801-692	14 x 2-1/2	1
81.801-693	14 x 3	1
81.801-694	14 x 4	1
81.801-696	14 x 6	1
81.801-698	14 x 8	1
81.801-700	14 x 10	1

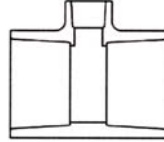

**TÉ RÉDUIT COLLÉ  
REDUCING TEE  
Soc**

NUMÉRO DE PIÈCE	DIMENSION	EMBALAGE STAND.
PART NUMBER	SIZE	STAND. PACK
81.801-702	14 x 12	1
81.801-706	14 x 16	1
81.801-751	16 x 2	1
81.801-752	16 x 2-1/2	1
81.801-753	16 x 3	1
81.801-754	16 x 4	1
81.801-756	16 x 6	1
81.801-758	16 x 8	1
81.801-760	16 x 10	1
81.801-762	16 x 12	1
81.801-764	16 x 14	1
81.801-781	18 x 2	1
81.801-783	18 x 3	1
81.801-784	18 x 4	1
81.801-786	18 x 6	1
81.801-788	18 x 8	1
81.801-790	18 x 10	1
81.801-792	18 x 12	1
81.801-794	18 x 14	1
81.801-796	18 x 16	1
81.801-814	20 x 4	1
81.801-816	20 x 6	1
81.801-818	20 x 8	1
81.801-820	20 x 10	1
81.801-822	20 x 12	1
81.801-824	20 x 14	1
81.801-826	20 x 16	1
81.801-828	20 x 18	1
81.801-904	24 x 4	1
81.801-906	24 x 6	1
81.801-908	24 x 8	1
81.801-910	24 x 10	1
81.801-912	24 x 12	1
81.801-914	24 x 14	1
81.801-916	24 x 16	1
81.801-918	24 x 18	1
81.801-920	24 x 20	1

Note: ( S ) normalement en inventaire / (S) normally available from inventory

PVC CÉDULE 80 GRIS / PVC SCHEDULE 80 GRAY

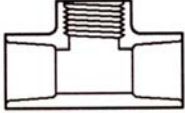

**TÉ COLLÉ X FILETÉ  
TEE  
Soc x Fipt**

NUMÉRO DE PIÈCE	DIMENSION	EMBALAGE STAND.
PART NUMBER	SIZE	STAND. PACK
81.802-002	1/4	25
81.802-005 (S)	1/2	20
81.802-007 (S)	3/4	15
81.802-010 (S)	1	15
81.802-012 (S)	1-1/4	10
81.802-015 (S)	1-1/2	10
81.802-020 (S)	2	10
81.802-030	3	5

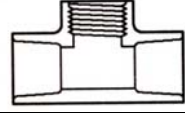

**TÉ RÉDUIT COLLÉ X FILETÉ  
REDUCING TEE  
Soc x Fipt**

NUMÉRO DE PIÈCE	DIMENSION	EMBALAGE STAND.
PART NUMBER	SIZE	STAND. PACK
81.802-101	3/4 x 1/2	15
81.802-130	1 x 1/2	15
81.802-131	1 x 3/4	15
81.802-166	1-1/4 x 1/2	10
81.802-167	1-1/4 x 3/4	15
81.802-168	1-1/4 x 1	10
81.802-209	1-1/2 x 1/2	25
81.802-210	1-1/2 x 3/4	20
81.802-211	1-1/2 x 1	10
81.802-212	1-1/2 x 1-1/4	10
81.802-247	2 x 1/2	10
81.802-248	2 x 3/4	10
81.802-249	2 x 1	10
81.802-250	2 x 1-1/4	10
81.802-251	2 x 1-1/2	10
81.802-287	2-1/2 x 1/2	10
81.802-288	2-1/2 x 3/4	10
81.802-289	2-1/2 x 1	10
81.802-290	2-1/2 x 1-1/4	10
81.802-291	2-1/2 x 1-1/2	10
81.802-292	2-1/2 x 2	10
81.802-333	3 x 1/2	5
81.802-334	3 x 3/4	5
81.802-335	3 x 1	5
81.802-336	3 x 1-1/4	5
81.802-337	3 x 1-1/2	5
81.802-338	3 x 2	5
81.802-339	3 x 2-1/2	5
81.802-415	4 x 1/2	5
81.802-416	4 x 3/4	5
81.802-417	4 x 1	5
81.802-418	2 x 1-1/4	1

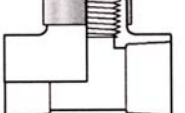

**TÉ RENFORCÉ COLLÉ X FILETÉ  
SPECIAL REINFORCED TEE  
Soc x SR Fipt**

NUMÉRO DE PIÈCE	DIMENSION	EMBALAGE STAND.
PART NUMBER	SIZE	STAND. PACK
81.802CSR-005	1/2	25
81.802CSR-040	4	5

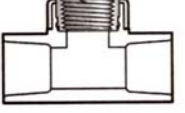

**TÉ DE TRANSITION  
TRANSITION TEE  
Soc x Fipt With Metal Thread Insert**

NUMÉRO DE PIÈCE	DIMENSION	EMBALAGE STAND.
PART NUMBER	SIZE	STAND. PACK
81.802CBR-005	1/2	20
81.802CBR-007	3/4	20

☞ Note: ( S ) normalement en inventaire / ( S ) normally available from inventory

**PVC CÉDULE 80 GRIS / PVC SCHEDULE 80 GRAY**

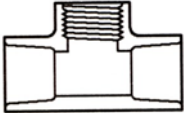
	<b>TÉ RÉDUIT COLLÉ X FILETÉ REDUCING TEE Soc x Fipt</b>	
<b>NUMÉRO DE PIÈCE</b>	<b>DIMENSION</b>	<b>EMBALAGE STAND.</b>
<b>PART NUMBER</b>	<b>SIZE</b>	<b>STAND. PACK</b>
81.802-419	4 x 1-1/2	5
81.802-420	4 x 2	5
81.802-421	4 x 2-1/2	5
81.802-422	4 x 3	5
81.802-525	6 x 1	4
81.802-526	6 x 1-1/4	4
81.802-527	6 x 1-1/2	4
81.802-528	6 x 2	0
81.802-529	6 x 2-1/2	4
81.802-530	6 x 3	4
81.802-532	6 x 4	0
81.802-578	8 x 2	0
81.802-580	8 x 3	0
81.802-582	8 x 4	0
81.802-621	10 x 2	1
81.802-623	10 x 3	0
81.802-624	10 x 4	0
81.802-661	12 x 2	2
81.802-663	12 x 3	0
81.802-664	12 x 4	0

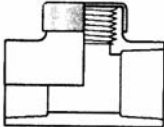
	<b>TÉ RENFORCÉ COLLÉ X FILETÉ SPECIAL REINFORCED REDUCING TEE Soc x SR Fipt</b>	
<b>NUMÉRO DE PIÈCE</b>	<b>DIMENSION</b>	<b>EMBALAGE STAND.</b>
<b>PART NUMBER</b>	<b>SIZE</b>	<b>STAND. PACK</b>
81.802CSR-072	1/2 x 1/4	25
81.802CSR-098	3/4 x 1/4	25
81.802CSR-101	3/4 x 1/2	50
81.802CSR-128	1 x 1/4	10
81.802CSR-164	1-1/4 x 1/4	5
81.802CSR-166	1-1/4 x 1/2	15
81.802CSR-207	1-1/2 x 1/4	10
81.802CSR-211	1-1/2 x 1	10
81.802CSR-245	2 x 1/4	10
81.802CSR-331	3 x 1/4	5
81.802CSR-333	3 x 1/2	5
81.802CSR-413	4 x 1/4	5
81.802CSR-415	4 x 1/2	5

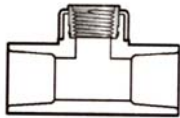
	<b>TÉ DE TRANSITION TRANSITION REDUCING TEE Soc x SR Fipt with metal Thread insert</b>	
<b>NUMÉRO DE PIÈCE</b>	<b>DIMENSION</b>	<b>EMBALAGE STAND.</b>
<b>PART NUMBER</b>	<b>SIZE</b>	<b>STAND. PACK</b>
81.802CBR-101	3/4 x 1/2	50

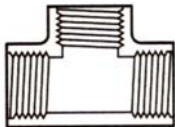
	<b>TÉ FILETÉ TEE Fipt</b>	
<b>NUMÉRO DE PIÈCE</b>	<b>DIMENSION</b>	<b>EMBALAGE STAND.</b>
<b>PART NUMBER</b>	<b>SIZE</b>	<b>STAND. PACK</b>
81.805-002 (S)	1/4	25
81.805-003 (S)	3/8	25
81.805-005 (S)	1/2	20
81.805-007 (S)	3/4	15
81.805-010 (S)	1	15
81.805-012 (S)	1-1/4	10

 Note: ( S ) normalement en inventaire / (S) normally available from inventory

PVC CÉDULE 80 GRIS / PVC SCHEDULE 80 GRAY

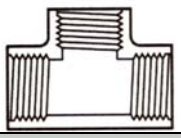

**TÉ FILETÉ  
TEE  
Fipt**

NUMÉRO DE PIÈCE	DIMENSION	EMBALAGE STAND.
PART NUMBER	SIZE	STAND. PACK
81.805-015 (S)	1-1/2	10
81.805-020 (S)	2	10
81.805-025 (S)	2-1/2	5
81.805-030 (S)	3	5
81.805-040	4	5

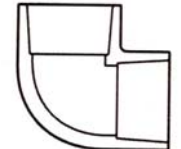

**COUDE 90° COLLÉ  
90° ELL  
Soc**

NUMÉRO DE PIÈCE	DIMENSION	EMBALAGE STAND.
PART NUMBER	SIZE	STAND. PACK
81.806-020 (S)	2	25
81.806-025 (S)	2-1/2	5
81.806-030 (S)	3	5
81.806-040 (S)	4	5
81.806-045	4-1/2	1
81.806-050	5	1
81.806-060 (S)	6	4
81.806-080 (S)	8	2
81.806-100 (S)	10	1
81.806-120 (S)	12	1
81.806-140	14	1
81.806-160	16	1
81.806-180	18	1
81.806-200	20	1
81.806-240	24	1
81.806-338	3 X 2	5
81.806-422	4 X 3	5

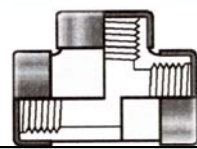

**TÉ RENFORCÉ FILETÉ  
SPECIAL REINFORCED TEE  
SR Fipt**

NUMÉRO DE PIÈCE	DIMENSION	EMBALAGE STAND.
PART NUMBER	SIZE	STAND. PACK
81.805CSR-002	1/4	20
81.805CSR-005	1/2	25
81.805CSR-007	3/4	25
81.805CSR-010	1	15
81.805CSR-015	1-1/2	10
81.805CSR-020	2	10

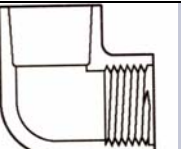

**COUDE 90° COLLÉ X FILETÉ  
90° ELL  
Soc x Fipt**

NUMÉRO DE PIÈCE	DIMENSION	EMBALAGE STAND.
PART NUMBER	SIZE	STAND. PACK
81.807-002	1/4	25
81.807-003	3/8	25
81.807-005 (S)	1/2	20
81.807-007 (S)	3/4	20
81.807-010 (S)	1	20
81.807-012 (S)	1-1/4	10
81.807-015 (S)	1-1/2	10
81.807-020 (S)	2	10

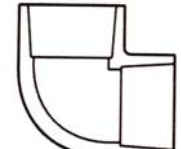

**COUDE 90° COLLÉ  
90° ELL  
Soc**

NUMÉRO DE PIÈCE	DIMENSION	EMBALAGE STAND.
PART NUMBER	SIZE	STAND. PACK
81.806-002 (S)	1/4	25
81.806-003 (S)	3/8	20
81.806-005 (S)	1/2	20
81.806-007 (S)	3/4	20
81.806-010 (S)	1	10
81.806-012 (S)	1-1/4	10
81.806-015 (S)	1-1/2	10

Note: ( S ) normalement en inventaire / (S) normally available from inventory



PVC CÉDULE 80 GRIS / PVC SCHEDULE 80 GRAY

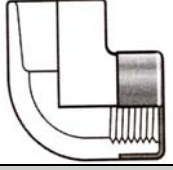

**COUDE 90° RENFORCÉ COLLÉ X FILETÉ**  
**SPECIAL REINFORCED 90° ELL**  
*Soc x SR Fipt*

NUMÉRO DE PIÈCE	DIMENSION	EMBALAGE STAND.
PART NUMBER	SIZE	STAND. PACK
81.807CSR-010	1	50
81.807CSR-020	2	10
81.807CSR-040	4	4

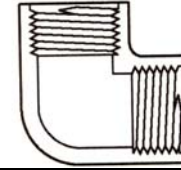

**COUDE 90° FILETÉ**  
**90° ELL**  
*Fipt*

NUMÉRO DE PIÈCE	DIMENSION	EMBALAGE STAND.
PART NUMBER	SIZE	STAND. PACK
81.808-002 (S)	1/4	25
81.808-003 (S)	3/8	25
81.808-005 (S)	1/2	20
81.808-007 (S)	3/4	20
81.808-010 (S)	1	15
81.808-012 (S)	1-1/4	10
81.808-015 (S)	1-1/2	10
81.808-020 (S)	2	10
81.808-025 (S)	2-1/2	5
81.808-030 (S)	3	5
81.808-040	4	5

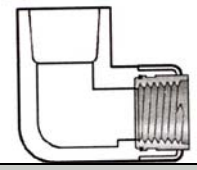

**COUDE 90° DE TRANSITION**  
**TRANSITION 90° ELL**  
*Soc x Fipt with metal thread insert*

NUMÉRO DE PIÈCE	DIMENSION	EMBALAGE STAND.
PART NUMBER	SIZE	STAND. PACK
81.807-005CBR	1/2	20
81.807-007CBR	3/4	20

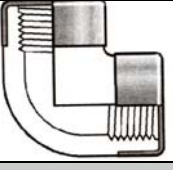

**COUDE 90° RENFORCÉ FILETÉ**  
**SPECIAL REINFORCED 90° ELL**  
*SR Fipt*

NUMÉRO DE PIÈCE	DIMENSION	EMBALAGE STAND.
PART NUMBER	SIZE	STAND. PACK
81.808CSR-005	1/2	20
81.808CSR-007	3/4	20
81.808CSR-010	1	50
81.808CSR-012	1-1/4	25
81.808CSR-015	1-1/2	10
81.808CSR-020	2	10

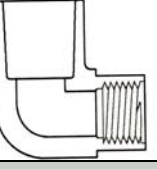

**COUDE 90° RÉDUIT COLLÉ X FILETÉ**  
**REDUCING 90° ELL**  
*Soc x Fipt*

NUMÉRO DE PIÈCE	DIMENSION	EMBALAGE STAND.
PART NUMBER	SIZE	STAND. PACK
81.807-101	3/4 x 1/2	10
81.807-130	1 x 1/2	10
81.807-131	1 x 3/4	10

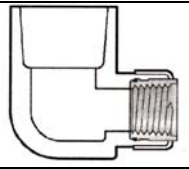

**COUDE 90° RÉDUIT DE TRANSITION**  
**TRANSITION REDUCING 90° ELL**  
*Soc x Fipt with metal Thread insert*

NUMÉRO DE PIÈCE	DIMENSION	EMBALAGE STAND.
PART NUMBER	SIZE	STAND. PACK
81.807CBR-101	3/4 x 1/2	20

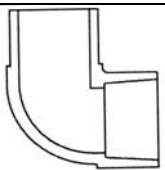

**COUDE 90° SPIGOT X COLLÉ**  
**90° STREET ELL**  
*Spig x Soc*

NUMÉRO DE PIÈCE	DIMENSION	EMBALAGE STAND.
PART NUMBER	SIZE	STAND. PACK
81.809-005	1/2	50
81.809-007	3/4	50
81.809-010	1	50

Note: ( S ) normalement en inventaire / (S) normally available from inventory

PVC CÉDULE 80 GRIS / PVC SCHEDULE 80 GRAY

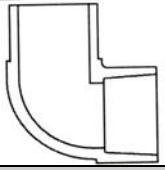

**COUDE 90° SPIGOT X COLLÉ**  
**90° STREET ELL**  
*Spig x Soc*

NUMÉRO DE PIÈCE	DIMENSION	EMBALAGE STAND.
PART NUMBER	SIZE	STAND. PACK
81.809-012	1-1/4	25
81.809-015	1-1/2	10
81.809-020	2	25
81.809-030	3	5
81.809-040	4	4
81.809-060	6	1
81.809-080	8	2
81.809-100	10	1
81.809-120	12	1

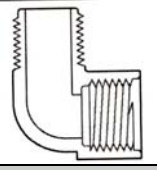

**COUDE 90° FILETÉ**  
**90° STREET ELL**  
*Mipt x Fipt*

NUMÉRO DE PIÈCE	DIMENSION	EMBALAGE STAND.
PART NUMBER	SIZE	STAND. PACK
81.812-002	1/4	50

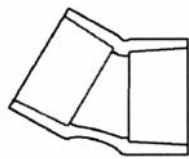

**COUDE 30° COLLÉ**  
**30° ELL**  
*Soc*

NUMÉRO DE PIÈCE	DIMENSION	EMBALAGE STAND.
PART NUMBER	SIZE	STAND. PACK
81.815-005	1/2	1
81.815-007	3/4	1
81.815-010	1	1
81.815-012	1-1/4	1
81.815-015	1-1/2	1
<b>81.815-020 (S)</b>	2	25
<b>81.815-025 (S)</b>	2-1/2	18
<b>81.815-030 (S)</b>	3	1
<b>81.815-040 (S)</b>	4	1
81.815-045	4-1/2	1
81.815-050	5	1
81.815-060	6	5
81.815-080	8	1
81.815-100	10	1
81.815-120	12	1
81.815-140	14	1
81.815-160	16	1
81.815-180	18	1
81.815-200	20	1
81.815-240	24	1

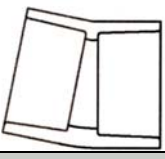

**COUDE 11-1/4° COLLÉ**  
**11-1/4° ELL**  
*Soc*

NUMÉRO DE PIÈCE	DIMENSION	EMBALAGE STAND.
PART NUMBER	SIZE	STAND. PACK
81.811-005	1/2	1
81.811-007	3/4	1
81.811-010	1	1
81.811-012	1-1/4	1
81.811-015	1-1/2	1
81.811-020	2	10
81.811-025	2-1/2	25
<b>81.811-030 (S)</b>	3	10
<b>81.811-040 (S)</b>	4	4
81.811-045	4-1/2	1
81.811-050	5	1
81.811-060	6	1
81.811-080	8	1
81.811-100	10	1
81.811-120	12	1
81.811-140	14	1
81.811-160	16	1
81.811-180	18	1
81.811-200	20	1
81.811-240	24	1

Note: ( S ) normalement en inventaire / (S) normally available from inventory

PVC CÉDULE 80 GRIS / PVC SCHEDULE 80 GRAY

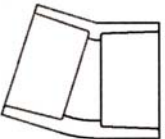

**COUDE 22-1/2° COLLÉ**  
**22-1/2° ELL**  
**Soc**

NUMÉRO DE PIÈCE	DIMENSION	EMBALAGE STAND.
PART NUMBER	SIZE	STAND. PACK
81.816-005	1/2	20
81.816-007	3/4	20
<b>81.816-010 (S)</b>	1	20
81.816-012	1-1/4	20
<b>81.816-015 (S)</b>	1-1/2	20
<b>81.816-020 (S)</b>	2	20
81.816-025	2-1/2	5
<b>81.816-030 (S)</b>	3	5
81.816-040	4	4
81.816-045	4-1/2	1
81.816-050	5	1
81.816-060	6	4
81.816-080	8	4
81.816-100	10	1
81.816-120	12	1
81.816-140	14	1
81.816-160	16	1
81.816-180	18	1
81.816-200	20	1
81.816-240	24	1

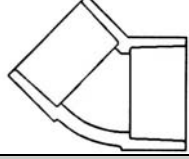

**COUDE 45° COLLÉ**  
**45° ELL**  
**Soc**

NUMÉRO DE PIÈCE	DIMENSION	EMBALAGE STAND.
PART NUMBER	SIZE	STAND. PACK
<b>81.817-030 (S)</b>	3	5
<b>81.817-040 (S)</b>	4	5
81.817-045	4-1/2	1
81.817-050	5	1
<b>81.817-060 (S)</b>	6	5
<b>81.817-080 (S)</b>	8	2
<b>81.817-100 (S)</b>	10	1
<b>81.817-120 (S)</b>	12	1
81.817-140	14	1
81.817-160	16	1
81.817-180	18	1
81.817-200	20	1
81.817-240	24	1

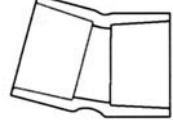

**COUDE 15° COLLÉE**  
**15° ELL**  
**Soc**

NUMÉRO DE PIÈCE	DIMENSION	EMBALAGE STAND.
PART NUMBER	SIZE	STAND. PACK
81.818-005	1/2	1
81.818-007	3/4	1
81.818-010	1	1
81.818-012	1-1/4	1
81.818-015	1-1/2	1
81.818-020	2	1
81.818-025	2-1/2	1
81.818-030	3	1
81.818-040	4	1
81.818-045	4-1/2	1
81.818-050	5	1
81.818-060	6	1
81.818-080	8	1
81.818-100	10	1
81.818-120	12	1
81.818-140	14	1
81.818-160	16	1

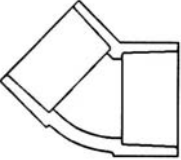

**COUDE 45° COLLÉ**  
**45° ELL**  
**Soc**

NUMÉRO DE PIÈCE	DIMENSION	EMBALAGE STAND.
PART NUMBER	SIZE	STAND. PACK
<b>81.817-002 (S)</b>	1/4	25
<b>81.817-003 (S)</b>	3/8	25
<b>81.817-005 (S)</b>	1/2	20
<b>81.817-007 (S)</b>	3/4	20
<b>81.817-010 (S)</b>	1	15
<b>81.817-012 (S)</b>	1-1/4	10
<b>81.817-015 (S)</b>	1-1/2	10
<b>81.817-020 (S)</b>	2	10
<b>81.817-025 (S)</b>	2-1/2	5

Note: ( S ) normalement en inventaire / ( S ) normally available from inventory

PVC CÉDULE 80 GRIS / PVC SCHEDULE 80 GRAY

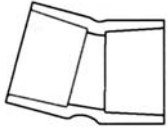

**COUDE 15° COLLÉ**  
**15° ELL**  
**Soc**

NUMÉRO DE PIÈCE	DIMENSION	EMBALAGE STAND.
PART NUMBER	SIZE	STAND. PACK
81.818-180	18	1
81.818-200	20	1
81.818-240	24	1

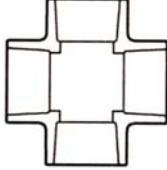

**CROIX COLLÉE**  
**CROSS**  
**Soc**

NUMÉRO DE PIÈCE	DIMENSION	EMBALAGE STAND.
PART NUMBER	SIZE	STAND. PACK
81.820-002	1/4	25
<b>81.820-005 (S)</b>	1/2	50
<b>81.820-007 (S)</b>	3/4	50
<b>81.820-010 (S)</b>	1	50
<b>81.820-012 (S)</b>	1-1/4	25
<b>81.820-015 (S)</b>	1-1/2	25
<b>81.820-020 (S)</b>	2	10
<b>81.820-025 (S)</b>	2-1/2	10
<b>81.820-030 (S)</b>	3	5
<b>81.820-040 (S)</b>	4	3
81.820-060	6	1
81.820-080	8	1
81.820-100	10	1
81.820-120	12	1
81.820-140	14	1
81.820-160	16	1
81.820-180	18	1
81.820-200	20	1
81.820-240	24	1

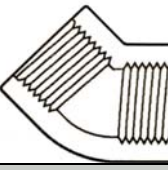

**COUDE 45° FILETÉ**  
**45° ELL**  
**Fipt**

NUMÉRO DE PIÈCE	DIMENSION	EMBALAGE STAND.
PART NUMBER	SIZE	STAND. PACK
81.819-002	1/4	25
81.819-003	3/8	25
<b>81.819-005 (S)</b>	1/2	20
<b>81.819-007 (S)</b>	3/4	10
<b>81.819-010 (S)</b>	1	10
<b>81.819-012 (S)</b>	1-1/4	10
<b>81.819-015 (S)</b>	1-1/2	10
<b>81.819-020 (S)</b>	2	10
<b>81.819-025 (S)</b>	2-1/2	5
<b>81.819-030 (S)</b>	3	5
<b>81.819-040 (S)</b>	4	5

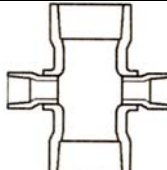

**CROIX RÉDUITE COLLÉE**  
**REDUCING CROSS**  
**Soc**

NUMÉRO DE PIÈCE	DIMENSION	EMBALAGE STAND.
PART NUMBER	SIZE	STAND. PACK
81.820-101	3/4 x 1/2	50
81.820-130	1 x 1/2	4
81.820-131	1 x 3/4	4
81.820-166	1-1/4 x 1/2	4
81.820-167	1-1/4 x 3/4	25
81.820-168	1-1/4 x 1	4

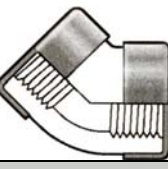

**COUDE 45° RENFORCÉ FILETÉ**  
**SPECIAL REINFORCED 45° ELL**  
**SR Fipt**

NUMÉRO DE PIÈCE	DIMENSION	EMBALAGE STAND.
PART NUMBER	SIZE	STAND. PACK
81.819CSR-007	3/4	10

Note: (S) normalement en inventaire / (S) normally available from inventory

PVC CÉDULE 80 GRIS / PVC SCHEDULE 80 GRAY

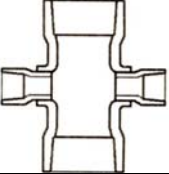

**CROIX RÉDUITE COLLÉE**  
**REDUCING CROSS**  
*Soc*

NUMÉRO DE PIÈCE	DIMENSION	EMBALAGE STAND.
PART NUMBER	SIZE	STAND. PACK
81.820-209	1-1/2 x 1/2	4
81.820-210	1-1/2 x 3/4	4
81.820-211	1-1/2 x 1	4
81.820-212	1-1/2 x 1-1/4	4
81.820-247	2 x 1/2	4
81.820-248	2 x 3/4	4
81.820-249	2 x 1	10
81.820-250	2 x 1-1/4	10
81.820-251	2 x 1-1/2	10
81.820-290	2-1/2 x 1-1/4	4
81.820-291	2-1/2 x 1-1/2	4
81.820-292	2-1/2 x 2	4
81.820-335	3 x 1	4
81.820-336	3 x 1-1/4	4
81.820-337	3 x 1-1/2	4
81.820-338	3 x 2	4
81.820-339	3 x 2-1/2	4
81.820-420	4 x 2	3
81.820-422	4 x 3	4
81.820-528	6 x 2	1
81.820-530	6 x 3	1
81.820-532	6 x 4	1
81.820-578	8 x 2	1
81.820-580	8 x 3	1
81.820-582	8 x 4	1
81.820-585	8 x 6	1
81.820-621	10 x 2	1
81.820-622	10 x 2-1/2	1
81.820-623	10 x 3	1
81.820-624	10 x 4	1
81.820-626	10 x 6	1
81.820-628	10 x 8	1
81.820-661	12 x 2	1
81.820-663	12 x 3	1
81.820-664	12 x 4	1
81.820-666	12 x 6	1

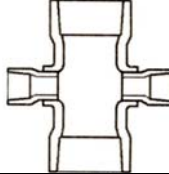

**CROIX RÉDUITE COLLÉE**  
**REDUCING CROSS**  
*Soc*

NUMÉRO DE PIÈCE	DIMENSION	EMBALAGE STAND.
PART NUMBER	SIZE	STAND. PACK
81.820-668	12 x 8	1
81.820-670	12 x 10	1
81.820-691	14 x 2	1
81.820-693	14 x 3	1
81.820-694	14 x 4	1
81.820-696	14 x 6	1
81.820-698	14 x 8	1
81.820-700	14 x 10	1
81.820-702	14 x 12	1
81.820-751	16 x 2	1
81.820-753	16 x 3	1
81.820-754	16 x 4	1
81.820-756	16 x 6	1
81.820-758	16 x 8	1
81.820-760	16 x 10	1
81.820-762	16 x 12	1
81.820-764	16 x 14	1
81.820-784	18 x 4	1
81.820-786	18 x 6	1
81.820-788	18 x 8	1
81.820-790	18 x 10	1
81.820-792	18 x 12	1
81.820-794	18 x 14	1
81.820-796	18 x 16	1
81.820-814	20 x 4	1
81.820-816	20 x 6	1
81.820-818	20 x 8	1
81.820-820	20 x 10	1
81.820-822	20 x 12	1
81.820-824	20 x 14	1
81.820-826	20 x 16	1
81.820-828	20 x 18	1
81.820-904	24 x 4	1
81.820-906	24 x 6	1
81.820-908	24 x 8	1
81.820-910	24 x 10	1

PVC CÉDULE 80 GRIS / PVC SCHEDULE 80 GRAY

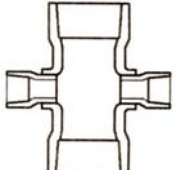

**CROIX RÉDUITE COLLÉE**  
**REDUCING CROSS**  
*Soc*

NUMÉRO DE PIÈCE	DIMENSION	EMBALAGE STAND.
PART NUMBER	SIZE	STAND. PACK
81.820-912	24 x 12	1
81.820-914	24 x 14	1
81.820-916	24 x 16	1
81.820-918	24 x 18	1
81.820-920	24 x 20	1

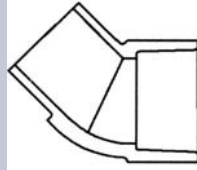

**COUDE 45° SPIGOT X COLLÉ**  
**45° STREET ELL**  
*Spig x Soc*

NUMÉRO DE PIÈCE	DIMENSION	EMBALAGE STAND.
PART NUMBER	SIZE	STAND. PACK
81.827-005	1/2	50
81.827-007	3/4	50
81.827-010	1	50
81.827-012	1-1/4	25
81.827-015	1-1/2	25
81.827-020	2	10
81.827-025	2-1/2	12
81.827-030	3	10
81.827-040	4	5
81.827-045	4-1/2	1
81.827-050	5	4
81.827-060	6	2
81.827-080	8	1
81.827-100	10	1
81.827-120	12	1
81.827-140	14	1
81.827-160	16	1
81.827-180	18	1
81.827-200	20	1
81.827-240	24	1

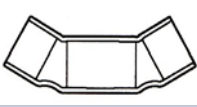

**COUDE 60° COLLÉ**  
**60° ELL**  
*Soc*

NUMÉRO DE PIÈCE	DIMENSION	EMBALAGE STAND.
PART NUMBER	SIZE	STAND. PACK
81.824-005	1/2	1
81.824-007	3/4	1
81.824-010	1	1
81.824-012	1-1/4	1
81.824-015	1-1/2	1
81.824-020	2	1
81.824-025	2-1/2	1
81.824-030	3	1
81.824-040	4	1
81.824-060	6	1
81.824-080	8	1
81.824-100	10	1
81.824-120	12	1
81.824-140	14	1
81.824-160	16	1
81.824-180	18	1
81.824-200	20	1
81.824-240	24	1

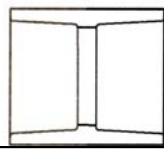

**MANCHON COLLÉ**  
**COUPLING**  
*Soc*

NUMÉRO DE PIÈCE	DIMENSION	EMBALAGE STAND.
PART NUMBER	SIZE	STAND. PACK
81.829-002 (S)	1/4	25
81.829-003 (S)	3/8	25
81.829-005 (S)	1/2	25
81.829-007 (S)	3/4	15
81.829-010 (S)	1	25
81.829-012 (S)	1-1/4	10
81.829-015 (S)	1-1/2	10

Note: ( S ) normalement en inventaire / (S) normally available from inventory

PVC CÉDULE 80 GRIS / PVC SCHEDULE 80 GRAY

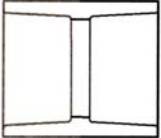

**MANCHON COLLÉ  
COUPLING  
Soc**

NUMÉRO DE PIÈCE	DIMENSION	EMBALAGE STAND.
PART NUMBER	SIZE	STAND. PACK
81.829-020 (S)	2	20
81.829-025 (S)	2-1/2	10
81.829-030 (S)	3	5
81.829-040 (S)	4	5
81.829-050 (S)	5	1
81.829-060 (S)	6	4
81.829-080 (S)	8	4
81.829-100 (S)	10	1
81.829-120 (S)	12	1
81.829-140	14	1
81.829-160	16	1
81.829-180	18	1
81.829-200	20	1
81.829-240	24	1

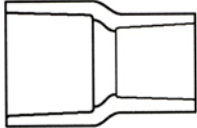

**MANCHON RÉDUIT COLLÉ  
REDUCER COUPLING  
Soc**

NUMÉRO DE PIÈCE	DIMENSION	EMBALAGE STAND.
PART NUMBER	SIZE	STAND. PACK
81.829-291 (S)	2-1/2 x 1-1/2	10
81.829-292 (S)	2-1/2 x 2	10
81.829-335	3 x 1	8
81.829-336	3 x 1-1/4	6
81.829-337	3 x 1-1/2	8
81.829-338 (S)	3 x 2	8
81.829-339 (S)	3 x 2-1/2	5
81.829-416	4 x 3/4	4
81.829-417	4 x 1	4
81.829-419	4 x 1-1/2	6
81.829-420	4 x 2	4
81.829-421	4 x 2-1/2	4
81.829-422 (S)	4 x 3	4
81.829-424	4-1/2 x 4	1
81.829-487	5 x 2-1/2	1
81.829-488	5 x 3	1
81.829-490	5 x 4	1
81.829-491	5 x 4-1/2	1
81.829-528	6 x 2	6
81.829-529	6 x 2-1/2	4
81.829-530	6 x 3	10
81.829-532 (S)	6 x 4	4
81.829-534	6 x 4-1/2	1
81.829-533	6 x 5	1
81.829-579	8 x 2-1/2	1
81.829-580	8 x 3	1
81.829-582	8 x 4	1
81.829-583	8 x 5	1
81.829-585	8 x 6	2
81.829-621	10 x 2	1
81.829-623	10 x 3	1
81.829-624	10 x 4	1
81.829-625	10 x 5	1
81.829-626	10 x 6	1
81.829-628	10 x 8	1
81.829-663	12 x 3	1
81.829-664	12 x 4	1
81.829-665	12 x 5	1
81.829-666	12 x 6	1

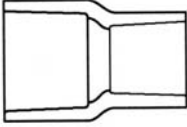



**MANCHON RÉDUIT COLLÉ  
REDUCER COUPLING  
Soc**

NUMÉRO DE PIÈCE	DIMENSION	EMBALAGE STAND.
PART NUMBER	SIZE	STAND. PACK
81.829-101 (S)	3/4 x 1/2	50
81.829-130 (S)	1 x 1/2	25
81.829-131 (S)	1 x 3/4	25
81.829-166 (S)	1-1/4 x 1/2	25
81.829-167	1-1/4 x 3/4	25
81.829-168	1-1/4 x 1	25
81.829-209 (S)	1-1/2 x 1/2	25
81.829-210 (S)	1-1/2 x 3/4	25
81.829-211 (S)	1-1/2 x 1	25
81.829-212 (S)	1-1/2 x 1-1/4	25
81.829-247 (S)	2 x 1/2	25
81.829-248 (S)	2 x 3/4	10
81.829-249 (S)	2 x 1	16
81.829-250 (S)	2 x 1-1/4	10
81.829-251 (S)	2 x 1-1/2	10

Note: ( S ) normalement en inventaire / (S) normally available from inventory

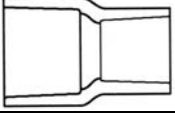
PVC CÉDULE 80 GRIS / PVC SCHEDULE 80 GRAY

		
<b>MANCHON RÉDUIT COLLÉ</b> <b>REDUCER COUPLING</b> <i>Soc</i>		
NUMÉRO DE PIÈCE	DIMENSION	EMBALAGE STAND.
PART NUMBER	SIZE	STAND. PACK
81.829-668	12 x 8	1
81.829-670	12 x 10	1
81.829-691	14 x 2	1
81.829-694	14 x 4	1
81.829-696	14 x 6	1
81.829-698	14 x 8	1
81.829-700	14 x 10	1
81.829-702	14 x 12	1
81.829-754	16 x 4	1
81.829-756	16 x 6	1
81.829-758	16 x 8	1
81.829-760	16 x 10	1
81.829-762	16 x 12	1
81.829-764	16 x 14	1
81.829-783	18 x 3	1
81.829-784	18 x 4	1
81.829-786	18 x 6	1
81.829-788	18 x 8	1
81.829-790	18 x 10	1
81.829-792	18 x 12	1
81.829-794	18 x 14	1
81.829-796	18 x 16	1
81.829-814	20 x 4	1
81.829-816	20 x 6	1
81.829-818	20 x 8	1
81.829-820	20 x 10	1
81.829-822	20 x 12	1
81.829-824	20 x 14	1
81.829-826	20 x 16	1
81.829-828	20 x 18	1
81.829-904	24 x 4	1
81.829-906	24 x 6	1
81.829-908	24 x 8	1
81.829-910	24 x 10	1
81.829-912	24 x 12	1
81.829-914	24 x 14	1
81.829-916	24 x 16	1
81.829-918	24 x 18	1
81.829-920	24 x 20	1

		
<b>MANCHON RÉDUIT EXCENTRIQUE</b> <b>COLLÉ</b> <b>ECCENTRIC REDUCER COUPLING</b> <i>Soc</i>		
NUMÉRO DE PIÈCE	DIMENSION	EMBALAGE STAND.
PART NUMBER	SIZE	STAND. PACK
81.829-E131	1 x 3/4	1
81.829-E249	2 x 1	1
81.829-E335	3 x 1	1
81.829-E337	3 x 1-1/2	1
81.829-E338	3 x 2	1
81.829-E420	4 x 2	1
81.829-E422	4 x 3	1
81.829-E528	6 x 2	1
81.829-E530	6 x 3	1
81.829-E532	6 x 4	1
81.829-E575	8 x 1	1
81.829-E577	8 x 1-1/2	1
81.829-E578	8 x 2	1
81.829-E580	8 x 3	1
81.829-E582	8 x 4	1
81.829-E583	8 x 5	1
81.829-E585	8 x 6	1
81.829-E624	10 x 4	1
81.829-E626	10 x 6	1
81.829-E628	10 x 8	1
81.829-E664	12 x 4	1
81.829-E666	12 x 6	1
81.829-E668	12 x 8	1
81.829-E670	12 x 10	1
81.829-E700	14 x 10	1
81.829-E702	14 x 12	1
81.829-E760	16 x 10	1
81.829-E762	16 x 12	1
81.829-E764	16 x 14	1

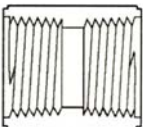

**PVC CÉDULE 80 GRIS / PVC SCHEDULE 80 GRAY**

	<b>MANCHON FILETÉ COUPLING Fipt</b>	
NUMÉRO DE PIÈCE	DIMENSION	EMBALAGE STAND.
PART NUMBER	SIZE	STAND. PACK
81.830-002 (S)	1/4	25
81.830-003 (S)	3/8	25
81.830-005 (S)	1/2	25
81.830-007 (S)	3/4	25
81.830-010 (S)	1	15
81.830-012 (S)	1-1/4	10
81.830-015 (S)	1-1/2	10
81.830-020 (S)	2	10
81.830-025 (S)	2-1/2	5
81.830-030	3	5
81.830-040	4	5
81.830-060	6	1
81.830-080	8	1

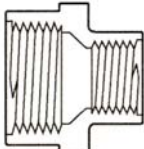
	<b>MANCHON RÉDUIT FILETÉ REDUCER COUPLING Fipt x Fipt</b>	
NUMÉRO DE PIÈCE	DIMENSION	EMBALAGE STAND.
PART NUMBER	SIZE	STAND. PACK
81.830-131 (S)	1 x 3/4	25
81.830-166	1-1/4 x 1/2	10
81.830-167 (S)	1-1/4 x 3/4	10
81.830-168 (S)	1-1/4 x 1	10
81.830-209	1-1/2 x 1/2	10
81.830-210 (S)	1-1/2 x 3/4	10
81.830-211 (S)	1-1/2 x 1	10
81.830-212 (S)	1-1/2 x 1-1/4	10
81.830-247	2 x 1/2	10
81.830-248	2 x 3/4	10
81.830-249 (S)	2 x 1	10
81.830-250 (S)	2 x 1-1/4	10
81.830-251 (S)	2 x 1-1/2	10
81.830-291	2-1/2 x 1-1/2	5
81.830-292	2-1/2 x 2	5
81.830-337	3 x 1-1/2	5
81.830-338	3 x 2	5
81.830-339	3 x 2-1/2	5
81.830-420	4 x 2	5
81.830-421	4 x 2-1/2	5
81.830-422	4 x 3	5

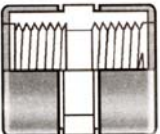
	<b>MANCHON RENFORCÉ FILETÉ SPECIAL REINFORCED COUPLING SR Fipt</b>	
NUMÉRO DE PIÈCE	DIMENSION	EMBALAGE STAND.
PART NUMBER	SIZE	STAND. PACK
81.830CSR-005	1/2	25
81.830CSR-007	3/4	25
81.830CSR-010	1	25
81.830CSR-012	1-1/4	10
81.830CSR-015	1-1/2	10
81.830CSR-020	2	10

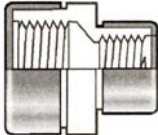
	<b>MANCHON RÉDUIT RENFORCÉ FILETÉ SPECIAL REINFORCED REDUCER COUPLING SR Fipt</b>	
NUMÉRO DE PIÈCE	DIMENSION	EMBALAGE STAND.
PART NUMBER	SIZE	STAND. PACK
81.830CSR-101	3/4 x 1/2	50
81.830CSR-130	1 x 1/2	50
81.830CSR-131	1 x 3/4	25
81.830CSR-168	1-1/4 x 1	25
81.830CSR-210	1-1/2 x 3/4	25
81.830CSR-211	1-1/2 x 1	10
81.830CSR-212	1-1/2 x 1-1/4	10
81.830CSR-249	2 x 1	25
81.830CSR-251	2 x 1-1/2	10

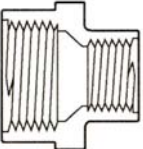
	<b>MANCHON RÉDUIT FILETÉ REDUCER COUPLING Fipt x Fipt</b>	
NUMÉRO DE PIÈCE	DIMENSION	EMBALAGE STAND.
PART NUMBER	SIZE	STAND. PACK
81.830-101 (S)	3/4 x 1/2	50
81.830-130 (S)	1 x 1/2	25

☞ Note: ( S ) normalement en inventaire / (S) normally available from inventory

PVC CÉDULE 80 GRIS / PVC SCHEDULE 80 GRAY

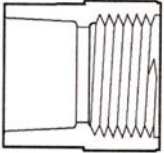

**ADAPTATEUR FEMELLE  
FEMALE ADAPTER  
Soc x Fipt**

NUMÉRO DE PIÈCE	DIMENSION	EMBALAGE STAND.
PART NUMBER	SIZE	STAND. PACK
81.835-002 (S)	1/4	25
81.835-003 (S)	3/8	25
81.835-005 (S)	1/2	25
81.835-007 (S)	3/4	15
81.835-010 (S)	1	15
81.835-012 (S)	1-1/4	10
81.835-015 (S)	1-1/2	10
81.835-020 (S)	2	10
81.835-025 (S)	2-1/2	5
81.835-030 (S)	3	5
81.835-040 (S)	4	5
81.835-060	6	6
81.835-080	8	3
81.835-100	10	1
81.835-120	12	1

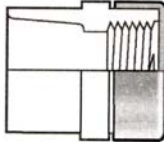

**ADAPTATEUR FEMELLE RENFORCÉ  
SPECIAL REINFORCED FEMALE  
ADAPTER  
Soc x SR Fipt**

NUMÉRO DE PIÈCE	DIMENSION	EMBALAGE STAND.
PART NUMBER	SIZE	STAND. PACK
81.835CSR-020	2	10
81.835CSR-025	2-1/2	5
81.835CSR-030	3	5
81.835CSR-040	4	5
81.835CSR-060	6	6

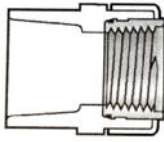

**ADAPTATEUR FEMELLE DE  
TRANSITION  
TRANSITION FEMALE ADAPTER  
Soc x Fipt with metal Thread insert**

NUMÉRO DE PIÈCE	DIMENSION	EMBALAGE STAND.
PART NUMBER	SIZE	STAND. PACK
81.835CBR-005	1/2	25
81.835CBR-007	3/4	15
81.835CBR-010	1	15
81.835CBR-012	1-1/4	15
81.835CBR-015	1-1/2	10
81.835CBR-020	2	5

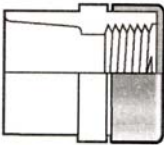

**ADAPTATEUR FEMELLE RENFORCÉ  
SPECIAL REINFORCED FEMALE  
ADAPTER  
Soc x SR Fipt**

NUMÉRO DE PIÈCE	DIMENSION	EMBALAGE STAND.
PART NUMBER	SIZE	STAND. PACK
81.835CSR-002	1/4	25
81.835CSR-003	3/8	25
81.835CSR-005	1/2	25
81.835CSR-007	3/4	25
81.835CSR-010	1	25
81.835CSR-012	1-1/4	10
81.835CSR-015	1-1/2	10

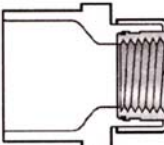

**ADAPTATEUR FEMELLE RÉDUIT DE  
TRANSITION  
TRANSITION FEMALE ADAPTER  
Soc x Fipt with metal Thread insert**

NUMÉRO DE PIÈCE	DIMENSION	EMBALAGE STAND.
PART NUMBER	SIZE	STAND. PACK
81.835CBR-101	3/4 x 1/2	50

☞ Note: ( S ) normalement en inventaire / (S) normally available from inventory

**PVC CÉDULE 80 GRIS / PVC SCHEDULE 80 GRAY**

<b>NUMÉRO DE PIÈCE</b>	<b>DIMENSION</b>	<b>EMBALAGE STAND.</b>
<b>PART NUMBER</b>	<b>SIZE</b>	<b>STAND. PACK</b>
81.835CSR-074	1/2 x 3/4	50
81.835CSR-101	3/4 x 1/2	50
81.835CSR-102	3/4 x 1	50
81.835CSR-130	1 x 1/2	50
81.835CSR-131	1 x 3/4	25

<b>NUMÉRO DE PIÈCE</b>	<b>DIMENSION</b>	<b>EMBALAGE STAND.</b>
<b>PART NUMBER</b>	<b>SIZE</b>	<b>STAND. PACK</b>
81.836R-005	1/2	25
81.836R-007	3/4	25
81.836R-010	1	10

<b>NUMÉRO DE PIÈCE</b>	<b>DIMENSION</b>	<b>EMBALAGE STAND.</b>
<b>PART NUMBER</b>	<b>SIZE</b>	<b>STAND. PACK</b>
81.836-005 (S)	1/2	25
81.836-007 (S)	3/4	25
81.836-010 (S)	1	10
81.836-012 (S)	1-1/4	10
81.836-015 (S)	1-1/2	10
81.836-020 (S)	2	10
81.836-025 (S)	2-1/2	5
81.836-030 (S)	3	5
81.836-040 (S)	4	5
81.836-050	5	1
81.836-060 (S)	6	5
81.836-080	8	1
81.836-100	10	1
81.836-120	12	1

<b>NUMÉRO DE PIÈCE</b>	<b>DIMENSION</b>	<b>EMBALAGE STAND.</b>
<b>PART NUMBER</b>	<b>SIZE</b>	<b>STAND. PACK</b>
81.837-052 (S)	3/8 x 1/4	50
81.837-072 (S)	1/2 x 1/4	50
81.837-073 (S)	1/2 x 3/8	50
81.837-101 (S)	3/4 x 1/2	50
81.837-129 (S)	1 x 3/8	50
81.837-130 (S)	1 x 1/2	50
81.837-131 (S)	1 x 3/4	50
81.837-166 (S)	1-1/4 x 1/2	25
81.837-167 (S)	1-1/4 x 3/4	25
81.837-168 (S)	1-1/4 x 1	25
81.837-209 (S)	1-1/2 x 1/2	25
81.837-210 (S)	1-1/2 x 3/4	25
81.837-211 (S)	1-1/2 x 1	25
81.837-212 (S)	1-1/2 x 1-1/4	25
81.837-247 (S)	2 x 1-1/2	10
81.837-248 (S)	2 x 3/4	10
81.837-249 (S)	2 x 1	10
81.837-250 (S)	2 x 1-1/4	10
81.837-251 (S)	2 x 1-1/2	10
81.837-287 (S)	2-1/2 x 1/2	5
81.837-288 (S)	2-1/2 x 3/4	5
81.837-289 (S)	2-1/2 x 1	5
81.837-290 (S)	2-1/2 x 1-1/4	10
81.837-291 (S)	2-1/2 x 1-1/2	10

☞ Note: ( S ) normalement en inventaire / (S) normally available from inventory

PVC CÉDULE 80 GRIS / PVC SCHEDULE 80 GRAY

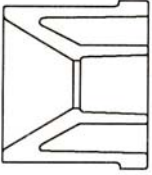
 <p><b>RÉDUIT SPIGOT X COLLÉ REDUCER BUSHING FLUSH STYLE Spig x Soc</b></p>		
NUMÉRO DE PIÈCE	DIMENSION	EMBALAGE STAND.
PART NUMBER	SIZE	STAND. PACK
<b>81.837-292 (S)</b>	2-1/2 x 2	15
<b>81.837-335 (S)</b>	3 x 1	10
<b>81.837-336 (S)</b>	3 x 1-1/4	10
<b>81.837-337 (S)</b>	3 x 1-1/2	10
<b>81.837-338 (S)</b>	3 x 2	10
<b>81.837-339 (S)</b>	3 x 2-1/2	15
81.837-417	4 x 1	6
81.837-418	4 x 1-1/4	6
81.837-419	4 x 1-1/2	6
<b>81.837-420 (S)</b>	4 x 2	6
<b>81.837-421 (S)</b>	4 x 2-1/2	6
<b>81.837-422 (S)</b>	4 x 3	6
81.837-490	5 x 4	1
81.837-524	6 x 3/4	5
81.837-525	6 x 1	1
81.837-526	6 x 1-1/4	5
81.837-527	6 x 1-1/2	5
<b>81.837-528 (S)</b>	6 x 2	5
81.837-529	6 x 2-1/2	5
<b>81.837-530 (S)</b>	6 x 3	5
<b>81.837-532 (S)</b>	6 x 4	5
81.837-533	6 x 5	1
81.837-577	8 x 1-1/2	4
81.837-578	8 x 2	4
81.837-580	8 x 3	6
<b>81.837-582 (S)</b>	8 x 4	6
81.837-583	8 x 5	1
<b>81.837-585 (S)</b>	8 x 6	4
81.837-621	10 x 2	2
81.837-622	10 x 2-1/2	2
81.837-623	10 x 3	2
81.837-624	10 x 4	2
81.837-625	10 x 5	1
81.837-626	10 x 6	4
81.837-628	10 x 8	4
81.837-663	12 x 3	2
81.837-664	12 x 4	2
81.837-666	12 x 6	2

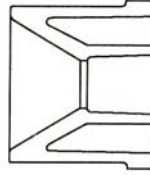
 <p><b>RÉDUIT SPIGOT X COLLÉ REDUCER BUSHING FLUSH STYLE Spig x Soc</b></p>		
NUMÉRO DE PIÈCE	DIMENSION	EMBALAGE STAND.
PART NUMBER	SIZE	STAND. PACK
81.837-668	12 x 8	2
81.837-670	12 x 10	2
81.837-694	14 x 4	1
81.837-696	14 x 6	1
81.837-698	14 x 8	1
81.837-700	14 x 10	1
81.837-702	14 x 12	1
81.837-754	16 x 4	1
81.837-756	16 x 6	1
81.837-758	16 x 8	1
81.837-760	16 x 10	1
81.837-762	16 x 12	1
81.837-764	16 x 14	1
81.837-786	18 x 6	1
81.837-788	18 x 8	1
81.837-790	18 x 10	1
81.837-792	18 x 12	1
81.837-794	18 x 14	1
81.837-796	18 x 16	1
81.837-816	20 x 6	1
81.837-818	20 x 8	1
81.837-820	20 x 10	1
81.837-822	20 x 12	1
81.837-824	20 x 14	1
81.837-826	20 x 16	1
81.837-828	20 x 18	1
81.837-906	24 x 6	1
81.837-908	24 x 8	1
81.837-910	24 x 10	1
81.837-912	24 x 12	1
81.837-914	24 x 14	1
81.837-912	24 x 12	1
81.837-914	24 x 14	1
81.837-916	24 x 16	1
81.837-918	24 x 18	1
81.837-920	24 x 20	1

 Note: ( S ) normalement en inventaire / (S) normally available from inventory

PVC CÉDULE 80 GRIS / PVC SCHEDULE 80 GRAY

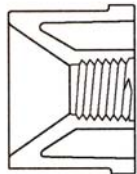

**RÉDUIT SPIGOT X FILETÉ**  
**REDUCER BUSHING FLUSH STYLE**  
*Spig x Fipt*

NUMÉRO DE PIÈCE	DIMENSION	EMBALAGE STAND.
PART NUMBER	SIZE	STAND. PACK
81.838-052 (S)	3/8 x 1/4	50
81.838-071 (S)	1/2 x 1/8	50
81.838-072 (S)	1/2 x 1/4	50
81.838-073 (S)	1/2 x 3/8	50
81.838-098 (S)	3/4 x 1/4	50
81.838-099 (S)	3/4 x 3/8	50
81.838-101 (S)	3/4 x 1/2	50
81.838-127 (S)	1 x 1/8	25
81.838-129 (S)	1 x 3/8	50
81.838-130 (S)	1 x 1/2	50
81.838-131 (S)	1 x 3/4	50
81.838-166 (S)	1-1/4 x 1/2	25
81.838-167 (S)	1-1/4 x 3/4	25
81.838-168 (S)	1-1/4 x 1	25
81.838-206 (S)	1-1/2 x 1/8	25
81.838-209 (S)	1-1/2 x 1/2	25
81.838-210 (S)	1-1/2 x 3/4	25
81.838-211 (S)	1-1/2 x 1	25
81.838-212 (S)	1-1/2 x 1-1/4	25
81.838-247 (S)	2 x 1-1/2	10
81.838-248 (S)	2 x 3/4	10
81.838-249 (S)	2 x 1	10
81.838-250 (S)	2 x 1-1/4	10
81.838-251 (S)	2 x 1-1/2	10
81.838-287 (S)	2-1/2 x 1/2	10
81.838-288 (S)	2-1/2 x 3/4	10
81.838-289 (S)	2-1/2 x 1	10
81.838-290 (S)	2-1/2 x 1-1/4	10
81.838-291 (S)	2-1/2 x 1-1/2	10
81.838-292 (S)	2-1/2 x 2	10
81.838-334 (S)	3 x 3/4	10
81.838-335 (S)	3 x 1	10
81.838-336 (S)	3 x 1-1/4	10
81.838-337 (S)	3 x 1-1/2	10
81.838-338 (S)	3 x 2	10
81.838-339 (S)	3 x 2-1/2	10
81.838-419	4 x 1-1/2	6
81.838-420 (S)	4 x 2	6
81.838-421 (S)	4 x 2-1/2	6

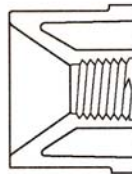

**RÉDUIT SPIGOT X FILETÉ**  
**REDUCER BUSHING FLUSH STYLE**  
*Spig x Fipt*

NUMÉRO DE PIÈCE	DIMENSION	EMBALAGE STAND.
PART NUMBER	SIZE	STAND. PACK
81.838-422 (S)	4 x 3	6
81.838-528	6 x 2	5
81.838-530	6 x 3	5
81.838-532	6 x 4	5

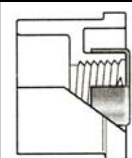

**RÉDUIT RENFORCÉ SPIGOT X FILETÉ**  
**SPECIAL REINFORCED REDUCER**  
**BUSHING FLUSH STYLE**  
*Spig x SR Fipt*

NUMÉRO DE PIÈCE	DIMENSION	EMBALAGE STAND.
PART NUMBER	SIZE	STAND. PACK
81.838CSR-128	1 x 1/4	25
81.838CSR-209	1-1/2 x 1/2	10
81.838CSR-210	1-1/2 x 3/4	10
81.838CSR-247	2 x 1/2	10
81.838CSR-248	2 x 3/4	10
81.838CSR-249	2 x 1	10
81.838CSR-334	3 x 3/4	10
81.838CSR-335	3 x 1	10
81.838CSR-336	3 x 1-1/4	10
81.838CSR-337	3 x 1-1/2	10
81.838CSR-532	6 x 4	5

 Note: ( S ) normalement en inventaire / (S) normally available from inventory

**PVC CÉDULE 80 GRIS / PVC SCHEDULE 80 GRAY**

<b>NUMÉRO DE PIÈCE</b>	<b>DIMENSION</b>	<b>EMBALAGE STAND.</b>
<b>PART NUMBER</b>	<b>SIZE</b>	<b>STAND. PACK</b>
81.839-052 (S)	3/8 x 1/4	50
81.839-072 (S)	1/2 x 1/4	50
81.839-073 (S)	1/2 x 3/8	50
81.839-098 (S)	3/4 x 1/4	50
81.839-099 (S)	3/4 x 3/8	50
81.839-101 (S)	3/4 x 1/2	50
81.839-128 (S)	1 x 1/4	25
81.839-129 (S)	1 x 3/8	50
81.839-130 (S)	1 x 1/2	50
81.839-131 (S)	1 x 3/4	50
81.839-166 (S)	1-1/4 x 1/2	25
81.839-167 (S)	1-1/4 x 3/4	25
81.839-168 (S)	1-1/4 x 1	25
81.839-209 (S)	1-1/2 x 1/2	25
81.839-210 (S)	1-1/2 x 3/4	25
81.839-211 (S)	1-1/2 x 1	25
81.839-212 (S)	1-1/2 x 1-1/4	25
81.839-247 (S)	2 x 1-1/2	10
81.839-248 (S)	2 x 3/4	10
81.839-249 (S)	2 x 1	10
81.839-250 (S)	2 x 1-1/4	10
81.839-251 (S)	2 x 1-1/2	10
81.839-292 (S)	2-1/2 x 2	10
81.839-337 (S)	3 x 1-1/2	10
81.839-338 (S)	3 x 2	10
81.839-339 (S)	3 x 2-1/2	10
81.839-420 (S)	4 x 2	6
81.839-422 (S)	4 x 3	6

<b>NUMÉRO DE PIÈCE</b>	<b>DIMENSION</b>	<b>EMBALAGE STAND.</b>
<b>PART NUMBER</b>	<b>SIZE</b>	<b>STAND. PACK</b>
81.839CSR-209	1-1/2 x 1/2	25
81.839CSR-210	1-1/2 x 3/4	25

<b>NUMÉRO DE PIÈCE</b>	<b>DIMENSION</b>	<b>EMBALAGE STAND.</b>
<b>PART NUMBER</b>	<b>SIZE</b>	<b>STAND. PACK</b>
81.839CSR-247	2 x 1/2	10
81.839CSR-248	2 x 3/4	10
81.839CSR-249	2 x 1	10
81.839CSR-420	4 x 2	6

<b>NUMÉRO DE PIÈCE</b>	<b>DIMENSION</b>	<b>EMBALAGE STAND.</b>
<b>PART NUMBER</b>	<b>SIZE</b>	<b>STAND. PACK</b>
81.842-005	1/2	50
81.842-007	3/4	50
81.842-010	1	50
81.842-012	1-1/4	20
81.842-015	1-1/2	25
81.842-020	2	20
81.842-030	3	5
81.842-040	4	4

<b>NUMÉRO DE PIÈCE</b>	<b>DIMENSION</b>	<b>EMBALAGE STAND.</b>
<b>PART NUMBER</b>	<b>SIZE</b>	<b>STAND. PACK</b>
81.844-005	1/2	25
81.844-007	3/4	15
81.844-010	1	15
81.844-012	1-1/4	10
81.844-015	1-1/2	10
81.844-020	2	10

Note: ( S ) normalement en inventaire / (S) normally available from inventory

PVC CÉDULE 80 GRIS / PVC SCHEDULE 80 GRAY

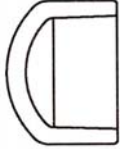
 <b>CAPUCHON COLLÉ</b> <b>CAP</b> <b>Soc</b>		
NUMÉRO DE PIÈCE	DIMENSION	EMBALAGE STAND.
PART NUMBER	SIZE	STAND. PACK
81.847-002 (S)	1/4	25
81.847-003 (S)	3/8	25
81.847-005 (S)	1/2	25
81.847-007 (S)	3/4	25
81.847-010 (S)	1	15
81.847-012 (S)	1-1/4	10
81.847-015 (S)	1-1/2	10
81.847-020 (S)	2	10
81.847-025 (S)	2-1/2	5
81.847-030 (S)	3	5
81.847-040 (S)	4	5
81.847-060 (S)	6	4
81.847-080 (S)	8	3
81.847-100	10	1
81.847-120	12	1
81.847-140	14	1
81.847-160	16	1
81.847-180	18	1
81.847-200	20	1
81.847-240	24	1

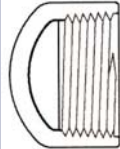
 <b>CAPUCHON FILETÉ</b> <b>CAP</b> <b>Fipt</b>		
NUMÉRO DE PIÈCE	DIMENSION	EMBALAGE STAND.
PART NUMBER	SIZE	STAND. PACK
81.848-025 (S)	2-1/2	5
81.848-030 (S)	3	5
81.848-040 (S)	4	5
81.848-060	6	1
81.848-080	8	1

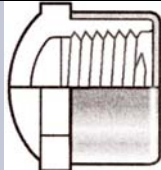
 <b>CAPUCHON RENFORCÉ FILETÉ</b> <b>SPECIAL REINFORCED CAP</b> <b>SR Fipt</b>		
NUMÉRO DE PIÈCE	DIMENSION	EMBALAGE STAND.
PART NUMBER	SIZE	STAND. PACK
81.848CSR-002	1/4	25
81.848CSR-003	3/8	25
81.848CSR-030	3	5

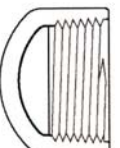
 <b>CAPUCHON FILETÉ</b> <b>CAP</b> <b>Fipt</b>		
NUMÉRO DE PIÈCE	DIMENSION	EMBALAGE STAND.
PART NUMBER	SIZE	STAND. PACK
81.848-002 (S)	1/4	25
81.848-003 (S)	3/8	25
81.848-005 (S)	1/2	25
81.848-007 (S)	3/4	25
81.848-010 (S)	1	15
81.848-012 (S)	1-1/4	10
81.848-015 (S)	1-1/2	10
81.848-020 (S)	2	10

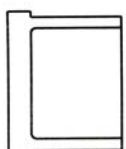
 <b>BOUCHON SPIGOT</b> <b>PLUG</b> <b>Spig</b>		
NUMÉRO DE PIÈCE	DIMENSION	EMBALAGE STAND.
PART NUMBER	SIZE	STAND. PACK
81.849-005	1/2	50
81.849-007	3/4	50
81.849-010	1	50
81.849-012	1-1/4	25
81.849-015	1-1/2	10
81.849-020 (S)	2	10

Note: ( S ) normalement en inventaire / (S) normally available from inventory

PVC CÉDULE 80 GRIS / PVC SCHEDULE 80 GRAY



**BOUCHON FILETÉ**  
**PLUG**  
*Mipt*

NUMÉRO DE PIÈCE	DIMENSION	EMBALAGE STAND.
PART NUMBER	SIZE	STAND. PACK
81.850-002 (S)	1/4	50
81.850-003 (S)	3/8	50
81.850-005 (S)	1/2	25
81.850-007 (S)	3/4	25
81.850-010 (S)	1	15
81.850-012 (S)	1-1/4	10
81.850-015 (S)	1-1/2	10
81.850-020 (S)	2	10
81.850-025 (S)	2-1/2	5
81.850-030 (S)	3	5
81.850-040 (S)	4	5
81.850-060	6	6



**BRIDE UNE PIÈCE FILETÉE**  
**FLANGE ONE PIECE**  
*Fipt*

NUMÉRO DE PIÈCE	DIMENSION	EMBALAGE STAND.
PART NUMBER	SIZE	STAND. PACK
81.852-005 (S)	1/2	25
81.852-007 (S)	3/4	25
81.852-010 (S)	1	15
81.852-012 (S)	1-1/4	15
81.852-015 (S)	1-1/2	20
81.852-020 (S)	2	10
81.852-025 (S)	2-1/2	10
81.852-030 (S)	3	10
81.852-040 (S)	4	5
81.852-060	6	1
81.852-080	8	1



**BRIDE UNE PIÈCE COLLÉE**  
**FLANGE ONE PIECE**  
*Soc*

NUMÉRO DE PIÈCE	DIMENSION	EMBALAGE STAND.
PART NUMBER	SIZE	STAND. PACK
81.851-H05 (S)	1/2	20
81.851-H07 (S)	3/4	20
81.851-H10 (S)	1	15
81.851-H12 (S)	1-1/4	10
81.851-H15 (S)	1-1/2	10
81.851-H20 (S)	2	5
81.851-H25 (S)	2-1/2	5
81.851-H30 (S)	3	5
81.851-H40 (S)	4	4
81.851-H50 (S)	5	5
81.851-H60 (S)	6	1
81.851-H80 (S)	8	3
81.851-H100 (S)	10	1
81.851-H120	12	1
81.851-H140	14	1



**BRIDE UNE PIÈCE RENFORCÉE**  
**FILETÉE**  
**SPECIAL REINFORCED FLANGE ONE**  
**PIECE THREADED**  
*SR Fipt*

NUMÉRO DE PIÈCE	DIMENSION	EMBALAGE STAND.
PART NUMBER	SIZE	STAND. PACK
81.852CSR-005	1/2	25
81.852CSR-007	3/4	25
81.852CSR-010	1	15
81.852CSR-012	1-1/4	15
81.852CSR-015	1-1/2	20
81.852CSR-020	2	10
81.852CSR-025	2-1/2	10
81.852CSR-030	3	10
81.852CSR-040	4	5

Note: ( S ) normalement en inventaire / (S) normally available from inventory



PVC CÉDULE 80 GRIS / PVC SCHEDULE 80 GRAY



**BRIDE PLEINE  
BLIND FLANGE**

NUMÉRO DE PIÈCE	DIMENSION	EMBALAGE STAND.
PART NUMBER	SIZE	STAND. PACK
81.853-H05 (S)	1/2	25
81.853-H07 (S)	3/4	25
81.853-H10 (S)	1	15
81.853-H12	1-1/4	20
81.853-H15 (S)	1-1/2	15
81.853-H20 (S)	2	10
81.853-H25	2-1/2	10
81.853-H30 (S)	3	10
81.853-H40 (S)	4	8
81.853-H50	5	1
81.853-H60 (S)	6	5
81.853-H80	8	5
81.853-100	10	3
81.853-120	12	2
81.853-140	14	1
81.853-160	16	1
81.853-180	18	1
81.853-200	20	1
81.853-240	24	1



**BRIDE TOURNANTE COLLÉE  
FLANGE VAN STONE STYLE  
Soc**

NUMÉRO DE PIÈCE	DIMENSION	EMBALAGE STAND.
PART NUMBER	SIZE	STAND. PACK
81.854-025 (S)	2-1/2	10
81.854-030 (S)	3	10
81.854-040 (S)	4	5
81.854-050 (S)	5	5
81.854-060 (S)	6	4
81.854-080 (S)	8	2
81.854-100 (S)	10	2
81.854-120 (S)	12	2
81.854-140	14	1
81.854-160	16	1
81.854-180	18	1
81.854-200	20	1
81.854-240	24	1



**BRIDE TOURNANTE COLLÉE  
FLANGE VAN STONE STYLE  
Soc**

NUMÉRO DE PIÈCE	DIMENSION	EMBALAGE STAND.
PART NUMBER	SIZE	STAND. PACK
81.854-005	1/2	25
81.854-007	3/4	25
81.854-010 (S)	1	15
81.854-012 (S)	1-1/4	15
81.854-015 (S)	1-1/2	20
81.854-020 (S)	2	10



**BRIDE TOURNANTE FILETÉE  
FLANGE VAN STONE STYLE  
Fipt**

NUMÉRO DE PIÈCE	DIMENSION	EMBALAGE STAND.
PART NUMBER	SIZE	STAND. PACK
81.855-005	1/2	25
81.855-007	3/4	25
81.855-010	1	15
81.855-012	1-1/4	15
81.855-015	1-1/2	20
81.855-020	2	10
81.855-025	2-1/2	10

Note: ( S ) normalement en inventaire / (S) normally available from inventory

**PVC CÉDULE 80 GRIS / PVC SCHEDULE 80 GRAY**

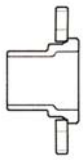
 <b>BRIDE TOURNANTE SPIGOT</b> <b>FLANGE VAN STONE STYLE</b> <i>Spig</i>		
NUMÉRO DE PIÈCE	DIMENSION	EMBALAGE STAND.
PART NUMBER	SIZE	STAND. PACK
81.856-005	1/2	25
81.856-007	3/4	25
81.856-010	1	15
81.856-012	1-1/4	15
81.856-015	1-1/2	15
81.856-020	2	10
81.856-025	2-1/2	10
81.856-030	3	10
81.856-040	4	5
81.856-050	5	4
81.856-060	6	2
81.856-080	8	2
81.856-100	10	2
81.856-120	12	1
81.856-140	14	1
81.856-160	16	1

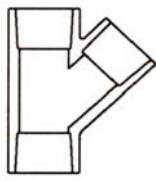
 <b>" Y " COLLÉ</b> <b>WYE</b> <i>Soc</i>		
NUMÉRO DE PIÈCE	DIMENSION	EMBALAGE STAND.
PART NUMBER	SIZE	STAND. PACK
81.875-005 (S)	1/2	25
81.875-007 (S)	3/4	25
81.875-010 (S)	1	20
81.875-012 (S)	1-1/4	20
81.875-015 (S)	1-1/2	20
81.875-020 (S)	2	10
81.875-025 (S)	2-1/2	4
81.875-030 (S)	3	5
81.875-040 (S)	4	4
81.875-060 (S)	6	3
81.875-080	8	1
81.875-080	8	1
81.875-100	10	1
81.875-120	12	1
81.875-140	14	1
81.875-160	16	1
81.875-180	18	1
81.875-200	20	1
81.875-240	24	1

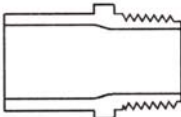
 <b>ADAPTATEUR MÂLE SPIGOT</b> <b>MALE ADAPTER</b> <i>Spig x Mipt</i>		
NUMÉRO DE PIÈCE	DIMENSION	EMBALAGE STAND.
PART NUMBER	SIZE	STAND. PACK
81.861-005	1/2	50
81.861-007	3/4	25
81.861-010 (S)	1	50
81.861-012	1-1/4	25
81.861-015 (S)	1-1/2	25
81.861-020 (S)	2	25

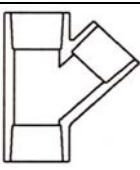
 <b>" Y " RÉDUIT COLLÉ</b> <b>REDUCING WYE</b> <i>Soc</i>		
NUMÉRO DE PIÈCE	DIMENSION	EMBALAGE STAND.
PART NUMBER	SIZE	STAND. PACK
81.875-101	3/4 x 1/2	20
81.875-130	1 x 1/2	20
81.875-131	1 x 3/4	20
81.875-166	1-1/4 x 1/2	20
81.875-167	1-1/4 x 3/4	20

☞ Note: ( S ) normalement en inventaire / (S) normally available from inventory

PVC CÉDULE 80 GRIS / PVC SCHEDULE 80 GRAY

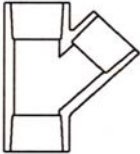
 <p><b>"Y" RÉDUIT COLLÉ REDUCING WYE Soc</b></p>		
NUMÉRO DE PIÈCE	DIMENSION	EMBALAGE STAND.
PART NUMBER	SIZE	STAND. PACK
81.875-168	1-1/4 x 1	20
81.875-209	1-1/2 x 1/2	20
81.875-210	1-1/2 x 3/4	20
81.875-211	1-1/2 x 1	20
81.875-212	1-1/2 x 1-1/4	10
81.875-247	2 x 1/2	10
81.875-248	2 x 3/4	10
81.875-249	2 x 1	10
81.875-250	2 x 1-1/4	10
81.875-251	2 x 1-1/2	10
81.875-335	3 x 1	5
81.875-336	3 x 1-1/4	5
81.875-337	3 x 1-1/2	5
81.875-338	3 x 2	4
81.875-339	3 x 2-1/2	5
81.875-420	4 x 2	4
81.875-421	4 x 2-1/2	4
81.875-422	4 x 3	4
81.875-525	6 x 1	5
81.875-528	6 x 2	5
81.875-530	6 x 3	5
81.875-532	6 x 4	5
81.875-578	8 x 2	0
81.875-579	8 x 2-1/2	1
81.875-580	8 x 3	1
81.875-582	8 x 4	1
81.875-585	8 x 6	1
81.875-621	10 x 2	1
81.875-622	10 x 2-1/2	1
81.875-623	10 x 3	1
81.875-624	10 x 4	1
81.875-625	10 x 5	1
81.875-626	10 x 6	1
81.875-628	10 x 8	1
81.875-661	12 x 2	1
81.875-662	12 x 2-1/2	1
81.875-663	12 x 3	1
81.875-664	12 x 4	1
81.875-666	12 x 6	1

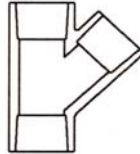
 <p><b>"Y" RÉDUIT COLLÉ REDUCING WYE Soc</b></p>		
NUMÉRO DE PIÈCE	DIMENSION	EMBALAGE STAND.
PART NUMBER	SIZE	STAND. PACK
81.875-668	12 x 8	1
81.875-670	12 x 10	1
81.875-694	14 x 4	1
81.875-696	14 x 6	1
81.875-698	14 x 8	1
81.875-700	14 x 10	1
81.875-702	14 x 12	1
81.875-754	16 x 4	1
81.875-756	16 x 6	1
81.875-758	16 x 8	1
81.875-760	16 x 10	1
81.875-762	16 x 12	1
81.875-764	16 x 14	1
81.875-784	18 x 4	1
81.875-786	18 x 6	1
81.875-788	18 x 8	1
81.875-790	18 x 10	1
81.875-792	18 x 12	1
81.875-794	18 x 14	1
81.875-796	18 x 16	1
81.875-814	20 x 4	1
81.875-816	20 x 6	1
81.875-818	20 x 8	1
81.875-820	20 x 10	1
81.875-822	20 x 12	1
81.875-824	20 x 14	1
81.875-826	20 x 16	1
81.875-828	20 x 18	1
81.875-904	24 x 4	1
81.875-906	24 x 6	1
81.875-908	24 x 8	1
81.875-910	24 x 10	1
81.875-912	24 x 12	1
81.875-914	24 x 14	1
81.875-916	24 x 16	1
81.875-918	24 x 18	1
81.875-920	24 x 20	1

**PVC CÉDULE 80 GRIS / PVC SCHEDULE 80 GRAY**

<b>NUMÉRO DE PIÈCE</b>	<b>DIMENSION</b>	<b>EMBALAGE STAND.</b>
<b>PART NUMBER</b>	<b>SIZE</b>	<b>STAND. PACK</b>
81.876-020	2	1
81.876-030	3	1
81.876-040	4	1
81.876-060	6	1
81.876-080	8	1
81.876-100	10	1
81.876-120	12	1

<b>NUMÉRO DE PIÈCE</b>	<b>DIMENSION</b>	<b>EMBALAGE STAND.</b>
<b>PART NUMBER</b>	<b>SIZE</b>	<b>STAND. PACK</b>
81.876-664	12 x 4	1
81.876-666	12 x 6	1
81.876-668	12 x 8	1
81.876-670	12 x 10	1

<b>NUMÉRO DE PIÈCE</b>	<b>DIMENSION</b>	<b>EMBALAGE STAND.</b>
<b>PART NUMBER</b>	<b>SIZE</b>	<b>STAND. PACK</b>
81.876-338	3 x 2	5
81.876-420	4 x 2	1
81.876-421	4 x 2-1/2	1
81.876-422	4 x 3	1
81.876-528	6 x 2	1
81.876-529	6 x 2-1/2	1
81.876-530	6 x 3	1
81.876-532	6 x 4	1
81.876-578	8 x 2	1
81.876-579	8 x 2-1/2	1
81.876-580	8 x 3	1
81.876-582	8 x 4	1
81.876-585	8 x 6	1
81.876-621	10 x 2	1
81.876-622	10 x 2-1/2	1
81.876-623	10 x 3	1
81.876-624	10 x 4	1
81.876-626	10 x 6	1
81.876-628	10 x 8	1
81.876-661	12 x 2	1
81.876-662	12 x 2-1/2	1
81.876-663	12 x 3	1

<b>NUMÉRO DE PIÈCE</b>	<b>DIMENSION</b>	<b>EMBALAGE STAND.</b>
<b>PART NUMBER</b>	<b>SIZE</b>	<b>STAND. PACK</b>
81.878CSR-005	1/2	50
81.878CSR-007	3/4	25
81.878CSR-010	1	50
81.878CSR-012	1-1/4	25
81.878CSR-015	1-1/2	25
81.878CSR-020	2	15
81.878CSR-030	3	5
81.878CSR-040	4	5

<b>NUMÉRO DE PIÈCE</b>	<b>DIMENSION</b>	<b>EMBALAGE STAND.</b>
<b>PART NUMBER</b>	<b>SIZE</b>	<b>STAND. PACK</b>
81.878CBR-010	1	15

**PVC CÉDULE 80 GRIS / PVC SCHEDULE 80 GRAY**

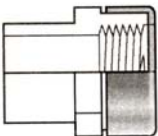
	<b>ADAPTATEUR FEMELLE RÉDUIT RENFORCÉ SPIGOT SPECIAL REINFORCED REDUCING SPIG FEMALE ADAPTER Spig x SR Fipt</b>	
NUMÉRO DE PIÈCE	DIMENSION	EMBALAGE STAND.
PART NUMBER	SIZE	STAND. PACK
81.878CSR-072	1/2 X 1/4	25
81.878CSR-098	3/4 X 1/4	50
81.878CSR-128	1 X 1/4	50

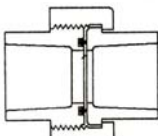
	<b>UNION COLLÉE, JOINT EPDM UNION Soc with EPDM O-ring Seal</b>	
NUMÉRO DE PIÈCE	DIMENSION	EMBALAGE STAND.
PART NUMBER	SIZE	STAND. PACK
81.897E-005	1/2	20
81.897E-007	3/4	20
81.897E-010	1	15
81.897E-012	1-1/4	10
81.897E-015	1-1/2	10
81.897E-020	2	5
81.897E-025	2-1/2	5
81.897E-030	3	5
81.897E-040	4	4
81.897E-060	6	1

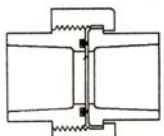
	<b>UNION COLLÉE, JOINT VITON UNION Soc with Viton O-ring Seal</b>	
NUMÉRO DE PIÈCE	DIMENSION	EMBALAGE STAND.
PART NUMBER	SIZE	STAND. PACK
81.897-002 (S)	1/4	25
81.897-003 (S)	3/8	25
81.897-005 (S)	1/2	20
81.897-007 (S)	3/4	20
81.897-010 (S)	1	15
81.897-012 (S)	1-1/4	10
81.897-015 (S)	1-1/2	10
81.897-020 (S)	2	5
81.897-025 (S)	2-1/2	5
81.897-030 (S)	3	5
81.897-040 (S)	4	4
81.897-060	6	1

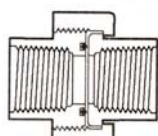
	<b>UNION FILETÉE, JOINT VITON UNION Fipt with Viton O-Ring Seal</b>	
NUMÉRO DE PIÈCE	DIMENSION	EMBALAGE STAND.
PART NUMBER	SIZE	STAND. PACK
81.898-002 (S)	1/4	25
81.898-003 (S)	3/8	25
81.898-005 (S)	1/2	20
81.898-007 (S)	3/4	20
81.898-010 (S)	1	15
81.898-012 (S)	1-1/4	10
81.898-015 (S)	1-1/2	10
81.898-020 (S)	2	5
81.898-025 (S)	2-1/2	5
81.898-030 (S)	3	5
81.898-040 (S)	4	4
81.898-060	6	1

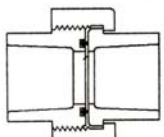
	<b>UNION COLLÉE, JOINT EPDM UNION Soc with EPDM O-ring Seal</b>	
NUMÉRO DE PIÈCE	DIMENSION	EMBALAGE STAND.
PART NUMBER	SIZE	STAND. PACK
81.897E-002	1/4	25
81.897E-003	3/8	25

☞ Note: ( S ) normalement en inventaire / (S) normally available from inventory

PVC CÉDULE 80 GRIS / PVC SCHEDULE 80 GRAY

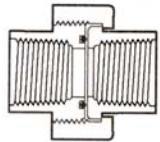

**UNION FILETÉE, JOINT EPDM  
UNION  
Fipt with EPDM O-Ring Seal**

NUMÉRO DE PIÈCE	DIMENSION	EMBALAGE STAND.
PART NUMBER	SIZE	STAND. PACK
81.898E-002	1/4	25
81.898E-003	3/8	25
81.898E-005	1/2	20
81.898E-007	3/4	20
81.898E-010	1	15
81.898E-012	1-1/4	10
81.898E-015	1-1/2	10
81.898E-020	2	5
81.898E-025	2-1/2	5
81.898E-030	3	5
81.898E-040	4	4
81.898E-060	6	1

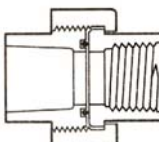

**UNION COLLÉE X FILETÉE, JOINT EPDM  
UNION  
Soc X Fipt with EPDM O-ring Seal**

NUMÉRO DE PIÈCE	DIMENSION	EMBALAGE STAND.
PART NUMBER	SIZE	STAND. PACK
81.899E-002	1/4	25
81.899E-003	3/8	25
81.899E-005	1/2	20
81.899E-007	3/4	20
81.899E-010	1	15
81.899E-012	1-1/4	10
81.899E-015	1-1/2	10
81.899E-020	2	5
81.899E-025	2-1/2	5
81.899E-030	3	5
81.899E-040	4	4
81.899E-060	6	1

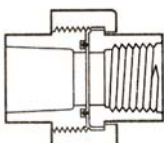

**UNION COLLÉE X FILETÉE JOINT VITON  
UNION  
Soc X Fipt with Viton O-ring Seal**

NUMÉRO DE PIÈCE	DIMENSION	EMBALAGE STAND.
PART NUMBER	SIZE	STAND. PACK
81.899-002	1/4	25
81.899-003	3/8	25
<b>81.899-005 (S)</b>	1/2	20
<b>81.899-007 (S)</b>	3/4	20
<b>81.899-010 (S)</b>	1	15
<b>81.899-012 (S)</b>	1-1/4	10
<b>81.899-015 (S)</b>	1-1/2	10
<b>81.899-020 (S)</b>	2	5
81.899-025	2-1/2	5
<b>81.899-030 (S)</b>	3	5
81.899-040	4	4
81.899-060	6	1

Note: ( S ) normalement en inventaire / (S) normally available from inventory